

Needle roller bearings, with machined rings, with flanges, without an inner ring

Principal dimensions			Basic load ratings		Speed ratings	Limiting speed	Designation
F _w	D	C	dynamic C	static C ₀	Reference speed		
mm			kN		r/min		-
63	80	45	89,7	190	6300	7000	RNA 6911

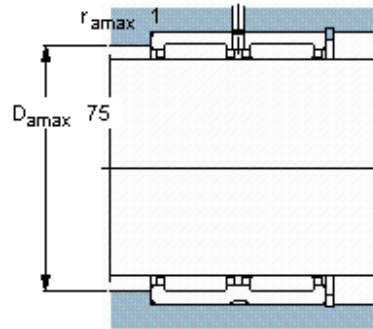
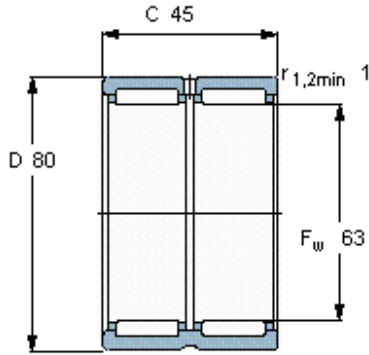

Appropriate seals

G seal	-
SD seal	-
CR seal	63x80x8 CRW1 R